

Read this instructions carefully before use for your safety

(ver.1.1 2014/8)

# RDA 2429

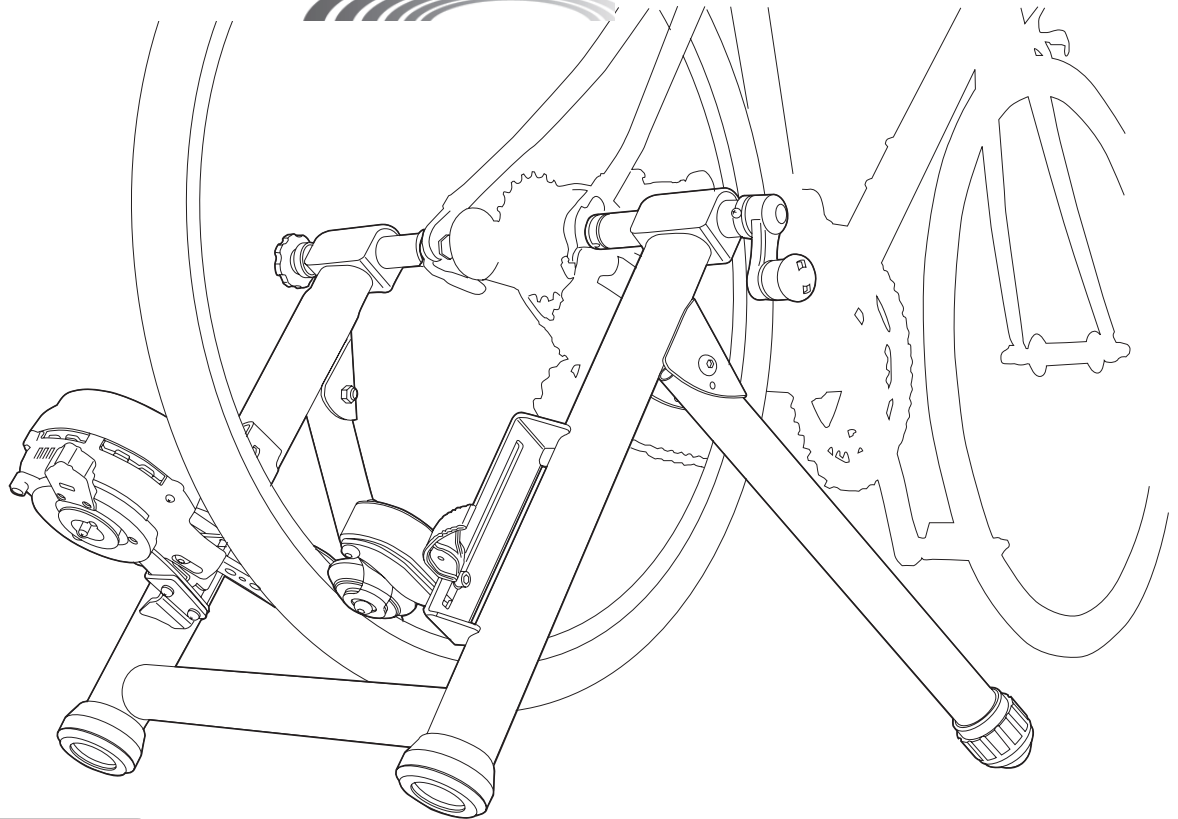

## Important Notes

- Only for normal 2-wheel bicycle with 110 – 170mm rear hub. Any internal transmission rear hub cannot be used on RDA2429.
- Adjust side pressure on roller wheels to have equal contact against the rim.
- We strongly suggest you use the supplied skewer to guarantee a proper fit with our trainer.
- The roller wheels have been specially designed to work with a wide variety of disc rims but we cannot guarantee 100% compatibility.

## Warranty Period

**1 year** from purchase

## Applicable Tire Size

24-inch – 29-inch / 650c – 700c (Max = 29 x 2.55")

## Contact

If you have any questions or need help, you should contact the dealer where you purchased or the Minoura distributor in your country first. The distributor can be found on our web site. Only when you cannot get enough service from them, you can contact us;

### **MINOURA Japan Headquarters** (for ALL customers, including Canada)

1197-1 Godo, Anpachi, Gifu 503-2305 Japan

Phone: +81-584-27-3131

Fax: +81-584-27-7505

Email: [minoura@minoura.jp](mailto:minoura@minoura.jp)

Web: [www.minoura.jp](http://www.minoura.jp)

### **MINOURA North America** (for the customers in the U.S.A. ONLY)

Hayward, California, U.S.A.

Phone: 1-510-538-8599

Fax: 1-510-538-5899

Email: [support@minourausa.com](mailto:support@minourausa.com)

**MADE IN JAPAN**

# RDA2429 Schematics

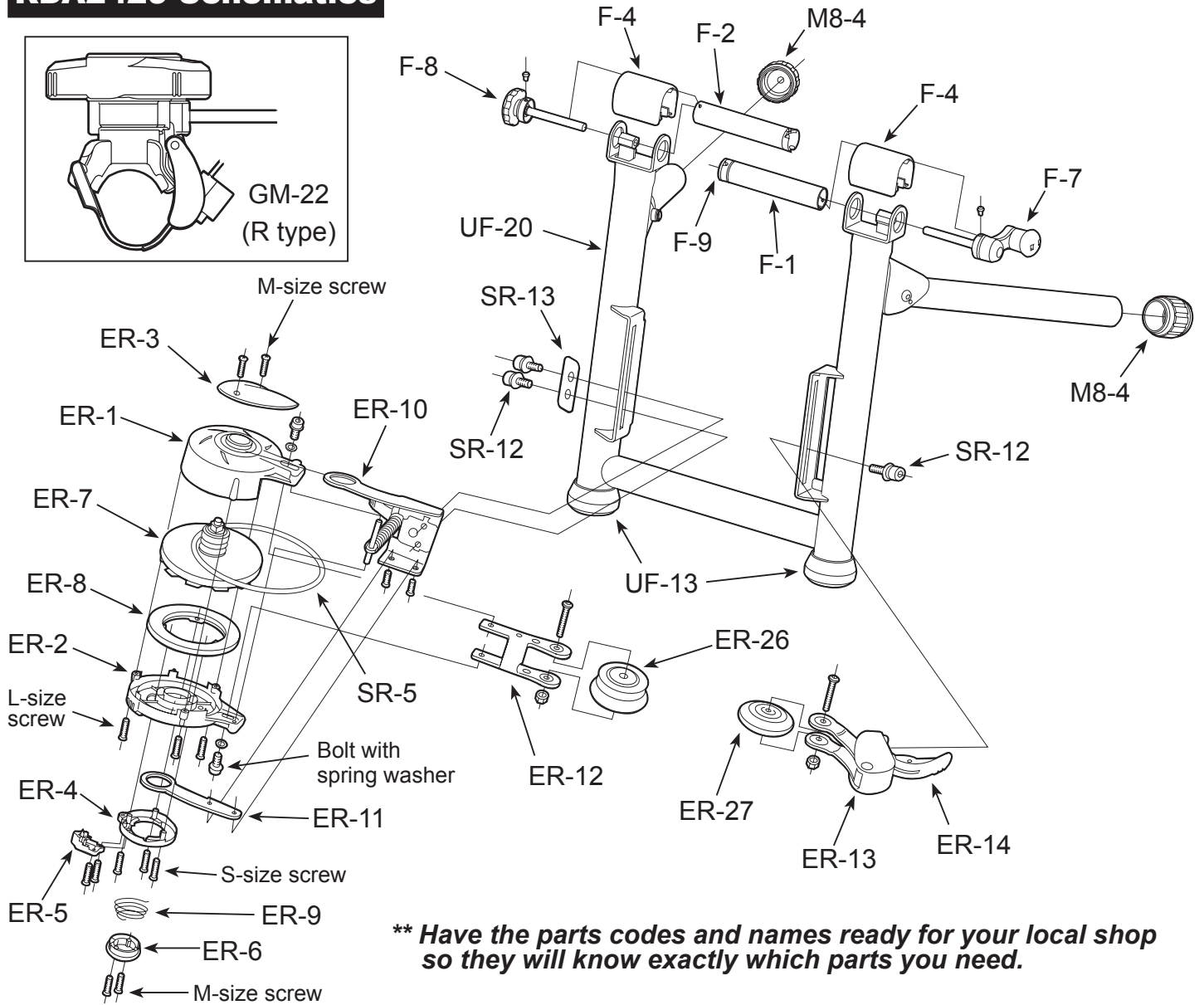
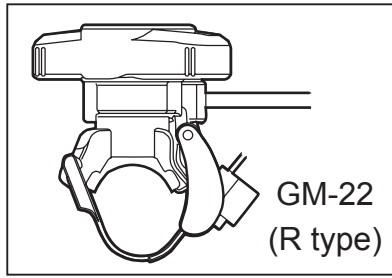

**\*\* Have the parts codes and names ready for your local shop so they will know exactly which parts you need.**

## Parts Code / Parts Name

- F-1 : Right Side Coupling
- F-2 : Left Side Coupling
- F-4 : Coupling Cover
- F-7 : Hub Clamp Handle
- F-8 : Wheel Position Adjust Knob
- F-9 : Plastic Cap (Grommet)
- UF-13 : Rubber Cap (45mm)
- UF-20 : RDA2429 Frame
- M8-4 : Rubber Foot Cap (35mm)
- SR-5 : V-Belt (K-16)
- SR-12 : Cap Screw M6x18
- SR-13 : Reinforcement Plate
- GM-22 : Remote Shifter (White)

- ER-1 : Upper Case
- ER-2 : Lower Case
- ER-3 : Top Clover
- ER-4 : Magnet Guide Ring
- ER-5 : Dial Lever
- ER-6 : Spring Holder
- ER-7 : Flywheel + Alloy Rotor
- ER-8 : Magnet
- ER-9 : Spring
- ER-10 : Main Arm + Pressure Lever
- ER-11 : Sub Arm
- ER-12 : Pulley Holder
- ER-13 : Assistant Roller Holder
- ER-14 : Tension Lever
- ER-26 : Drive Roller (engraved)
- ER-27 : Assistant Roller (engraved)

## IMPORTANT NOTES

- **Read all instructions carefully before use. And Keep the manual handy at all times.**
- **Do NOT use trainer for any other purpose than instructed.**
- **The trainer is manufactured to precise standards. Disassembling without Minoura's approval may void your warranty.**
- **Minoura offers 1-year limited warranty on the Mag unit and 5-year on the frame.**  
**For more detail, refer the enclosed "Minoura Limited Warranty Policy" card.**

 Use two-wheeled normal bikes only. Tandems and recumbent bikes may be used if balanced correctly. Confirm if your wheel size is in the range between 24-inch and 29-inch / 700c.

 You may use the quick release skewer currently on your bike, however we strongly recommend replacing your quick release skewer with the supplied one and keep installing the coupling protector cap (F-9) on to the right side coupling of the trainer. Otherwise the stability will not be guaranteed.

*Minoura is not responsible to any problem caused by using your own skewer.*

 Remove the coupling protector cap when you use a hub nut type wheel.  
Any hub with internal transmission system or very special type such as Shimano Saint or Hone cannot be used with this trainer

 Depending on the floor or carpet material, the rubber cap may stain. You should not put the trainer directly on the floor, and use a specific floor protection mat or large towel under trainer.

 Check the couplings supporting the rear hub for damage and cracks. Accidents may occur from cracked or damaged couplings.

 Setup the trainer on flat, horizontal and level floor for safe training.  
Open the legs fully to get maximum stability.  
Keep both hands on the handlebar at all times and maintain a normal riding position.

 Do not clamp the wheel axle by using the left side knob (F-8). The left side knob is only for pre-adjusting the wheel position for the best pedaling efficiency. Use the larger hub handle (F-7) to tighten the bike to the trainer.

 Do not over-tighten the Hub Clamp Handle. Over-tightening may cause damage to both the trainer and bike frame. The clamp handle should be a snug and secure fit. Do not force!

 Before use, make sure all bolts and nuts are securely fastened.

 Keep small children and pets away from the trainer, and keep hands and feet away from the spinning rollers and wheels at all times.

 Do not allow the rubber rollers to come in contact with the tire. Doing so may cause a cut and puncture in your tire.  
Make sure the rubber roller contacts the vertical area of the rim side wall only. Contacting the slanted area on the rim should cause damage to the rubber roller and the rim surface.

 Wipe all oil and moistures out from the rim surface and rollers everytime you use the trainer to keep necessary brake performance of your bike.

## HOW TO SETUP RDA2429 TRAINER

Required Tool: M5 Hex Wrench  
(included)

- 1 Fully open the legs and place RDA2429 on a flat and horizontal floor. Confirm all 4 leg points are touching the floor at same time to ensure the maximum stability.

**NOTE:** If legs are uneven when first opening the trainer, make sure both legs are fully extended.

- 2 Install the Mag Resistance Unit on the left side slot beside the trainer pillar by the supplied M6x18 bolts (SR-12) and the small plate (SR-13). (see Fig. A)  
Assistant Roller is set on the right side slot.

**NOTE:** You must use the Reinforcement Plate (SR-13) for installing the Mag unit. This plate will sandwich the slot plate from outside for mounting the heavy Mag unit and giving it extra stability. You don't need to tighten the bolts firmly yet. it will be done later.

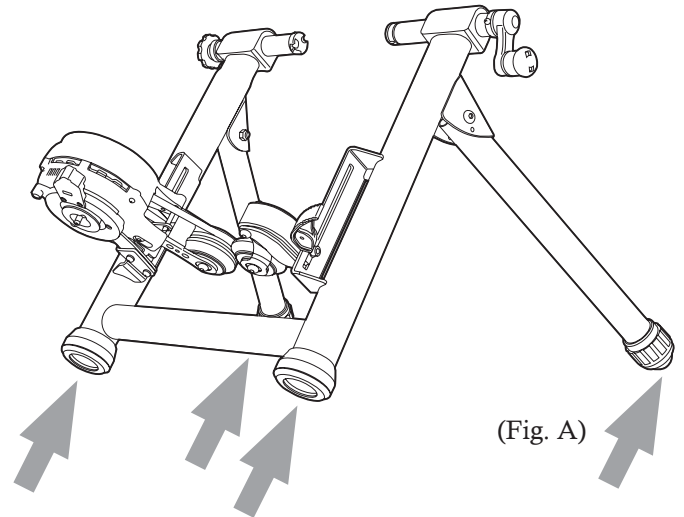

- 3 Open both couplings by turning the left side Knob (see Fig. B) and the right side Hub Handle (see Fig. C) anti-clockwise.

Left Side Adjust Knob

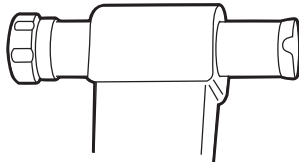

(Fig. B)

Right Side Hub Clamp Handle

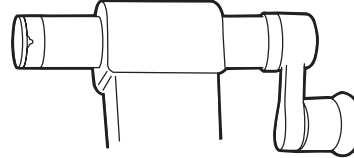

(Fig. C)

**NOTE:** Do not over-loosen the couplings, otherwise the knob or the hub handle may become unthreaded inside the frame.

**NOTE:** Please note that the left side knob is not for tightening the wheel hub but for pre-adjusting the wheel position in order to stabilize the roller pressure to the rim. Once you have set up the position, you basically no longer re-adjust the knob while using the same wheel.

- 4 Push the right side Tension Lever (ER-14) and the left side Pressure Lever (ER-10) to retract the rubber rollers to make enough space for installing the tire.

**NOTE:** If it's hard to retract the arm, assist with another hand to pull the roller.

- 5 Insert the left side of the skewer (Q/R lever side) into the left side coupling, and adjust the rotation of the coupling so the skewer lever sits securely in the large cut-out (see Fig. D).

**NOTE:** Failure to do so may cause the bike to be loose in the coupling, possibly causing the bike to fall out of the stand resulting in damage or injury.

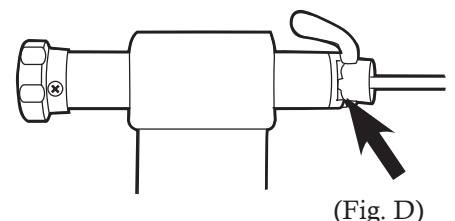

(Fig. D)

- 6** Hold the bike firmly by hand and align the skewer nut to the right side coupling. While keeping this position, turn the Hub Handle clockwise until the coupling comes into contact with the skewer nut. Keep tightening.

- 7** When you feel some resistance to tighten the handle more, stop tightening after two more revolutions. If you see the pillars start open due to the tightening power, it's normal.

- 8** Adjust each height of the Mag unit and the Assistant Roller to fit to your rear wheel perfectly, and then tighten the bolts firmly. (see Fig. E)

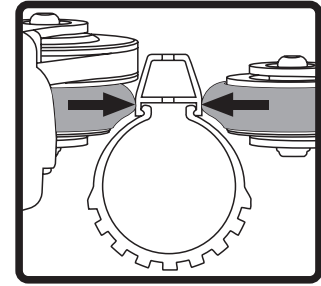

(Fig. E)

Be sure that the adjustment must be confirmed after tightening the M6x18 bolts.



**Each rubber roller is made to contact the rim ONLY. Contact with the tire may cause the tire to burst during use.**

**The rubber roller is engraved the bottom side to have clearance to fat tire, but make sure it doesn't touch the tire at all.**

- 9** Adjust the wheel position side to side as to both rubber rollers contact the same point of the rim equally. (see Fig. F)

There is a double-circle indicator on each pulley arm. This is just for your reference. Indicator is guide only for reference.

If the pressure of the drive roller against the rim is too weak, some slippage will occur when pedaling strongly. To avoid this problem, you should set the wheel a little leftward.

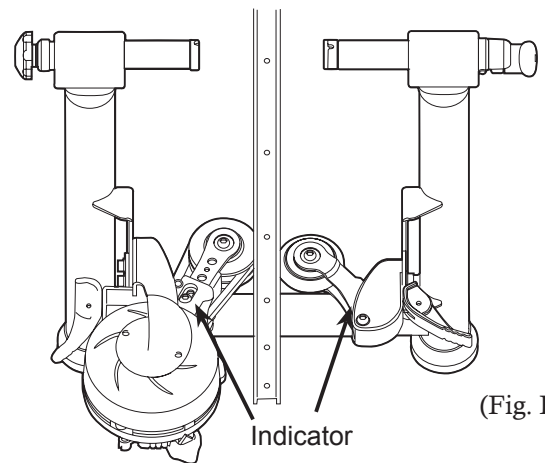

(Fig. F)

To change the wheel position, loosen the Hub Handle first, loosen the left side knob, then tighten the Hub Handle. If not enough, repeat this step.



**Both rubber rollers should contact the rim at same point equally, but it won't cause any serious problem even if the rollers are not aligned.**

## THE SKEWER NUT PROTECTOR

We strongly recommend you to replace your rear wheel quick release skewer to the supplied one at all times if your bike is equipped with a quick release skewer system. This will guarantee a fit with our couplings.

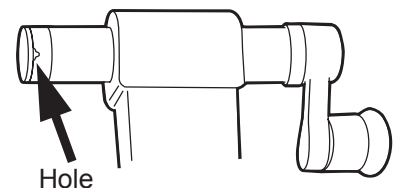

(Fig. G)

You can use this supplied skewer for the actual ride on the road.

The right side coupling has a black plastic Skewer Nut Protector "Grommet" (F-9). This is for protecting the skewer nut from damage during use.

If your rear wheel is not designed for the quick release skewer and uses a hub nut system, you should remove it by inserting a rod or a pen to the hole (see Fig. G) and then lifting up the Grommet.

## HOW TO ADJUST THE RESISTANCE LEVEL

The Mag unit provides 7 different levels of resistance power. It can be controlled via a manual lever (RDA2429-D) or a remote shifter (RDA2429-R). L is the lowest and H is the highest power.

It's also possible to adjust the resistance power by shifting the bike gear. However, if you use the inner front gear to reduce the power, it will increase the pedaling torque too much then it will make the pedaling feel very jerky.

So we recommend you to adjust the power on the Mag unit for smoother and more realistic training.



***On RDA2429-D, make sure the mag unit has stopped completely. Do not touch any moving parts such as wheel or belt.***



***The mag unit always has some resistance, even when setting at the lowest range. Some slippage is normal when the resistance level on the trainer is set too high.***



***Use just lighter level in the first 5 minutes for warming up your muscles and knee to avoid accident. You also should cool-down after session with lighter resistance.***

### RDA2429-D (Non-Remote)

#### How To Increase Power

To increase the power, slide the lever toward H symbol. (see Fig. H)

#### How To Reduce Power

To reduce the power, slide the lever toward L symbol. (see Fig. I)

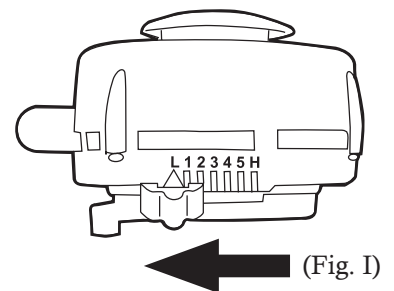
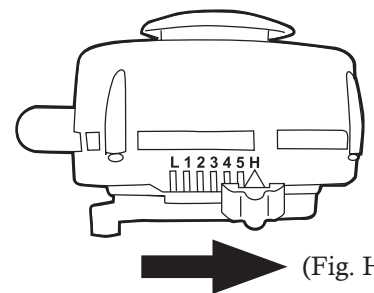

### RDA2429-R (Remote)

#### How To Increase Power

To increase the power, turn the lever toward H symbol (clockwise). (see Fig. J)

#### How To Reduce Power

To reduce the power, turn the lever toward L symbol (counter-clockwise). (see Fig. J)

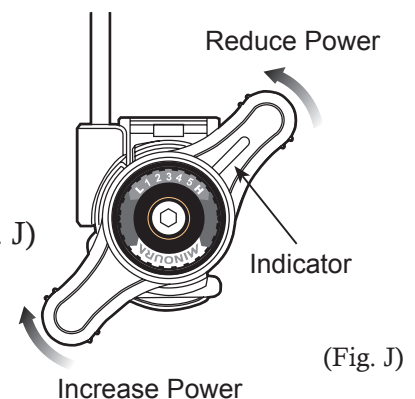

## HOW TO INSTALL REMOTE SHIFTER

**RDA2429-R model ONLY**

Required Tool: M4 Hex Wrench

The R model has a convenient remote shifter lever. You can install it on the handlebar or stem, then you can control the resistance level without getting off the bike.

The clamp band is made of thin and flexible soft plastic so it can be installed on aerodynamic shape handlebar or oval dimension stem.



***If your handlebar has quite special shape or the stem is square dimension type, the remote shifter cannot be installed.***

### Installing Remote Shifter:

- 1) Pull down the lever and release the clamp band from the hook.
- 2) Wind the band around handlebar or stem.
- 3) Put the band tip to the hook.
- 4) Pull up the lever to tighten the band.

The flexible plastic band is pre-adjusted to fit normal 22mm diameter handlebar.

If you need to mount onto an oversized or specially shaped handlebar or stem, adjust the band by turning the plastic screw on the band with an M4 hex wrench (see Fig. M).

*(Please be advised that this hex wrench doesn't come with the kit. Prepare by yourself.)*



***Both clamp band and screw are made of plastic so they are fragile. You should take off the hook to prevent from the breakage of those plastic parts.***

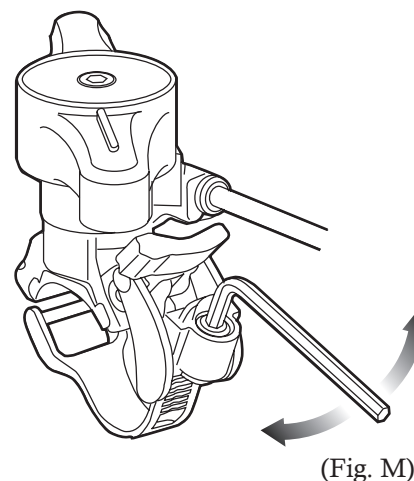
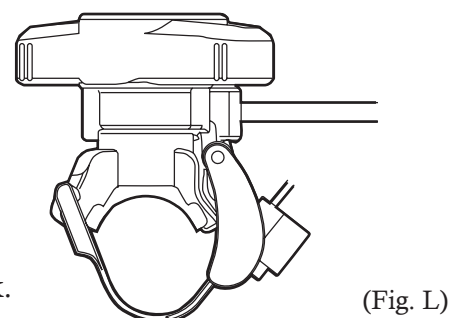
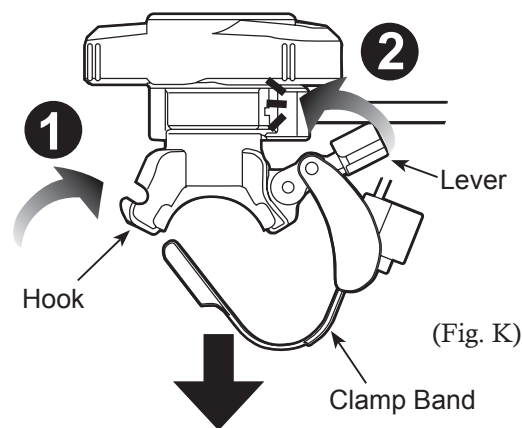

## HOW TO ADJUST CABLE TENSION

If you get unable to set at L or H even though you operate the remote shifter lever, it's the time to adjust the cable tension. Follow the steps below;

- 1) Straighten the cable as much as possible, and set the shifter at "H" position.
- 2) Pull out the small black plastic cap on the cable, then an adjusting screw gets exposed.
- 3) Put the black outer cable to the remote shifter, and put the adjusting screw to the outer cable.
- 4) While keeping this position, screw the lock nut toward the Mag unit until it touches the plastic parts.
- 5) Put the black plastic cap on.

## **ABOUT SLIPPAGE PROBLEM**

Minoura's Rim Drive System works off the wall of the rim, not the tire. This system allows use on a wide variety of rims including disc brake rims. Slipping will happen when pedaling strongly or the resistance on the mag unit is set high. This slippage is normal and to be expected.

If you experience slippage all the time you use the trainer, check the belt tension first by pushing down the belt with your finger. The K-16 V-belt will be worn down after long term of use but most reason for the slippage problem is caused by improper (too much or too less) tension adjustment.

To adjust the belt tension, loosen both upper and lower bolts which hold the pulley arm by an M5 hex wrench, then pull the arm outward by your hand and tighten the bolts firmly again.

If the V-belt is completely worn down or damaged, replace it.

This work requires high skill for disassembling and assembling the Mag unit. If you don't have confidence, please ask to the Minoura dealer where you purchased the trainer.